

Cylinder Head/Valve Train

Standards and Service Limits	3-2
Special Tools	3-3
Illustrated Index	3-4
Variable Valve Timing and Lift	
Electronic Control System	
Electrical Connectors	3-6
Troubleshooting	
— Self-diagnostic Procedure	3-8
Troubleshooting Flowchart	
— Spool Valve	3-10
— Oil Pressure Switch	3-12
Spool Valve Inspection	3-15
Cylinder Head Removal	3-16
Intake Manifold	3-19
Exhaust Manifold	3-20
Camshaft Pulleys	3-21
Rocker Arms	3-21
Camshafts	3-23
Valves	3-26
Valve Seats	3-27
Cylinder Head	3-28
Valve Guides	3-29
Valve Springs and Valve Seals	3-30
Rocker Arms Installation	3-31
Cylinder Head Installation	3-32
Camshaft Installation	3-33
Valve Clearance Adjustment	3-35
Rocker Arm Inspection	
Using Special Tools	3-37
Drive Belts	3-38

Standard and Service Limits

Umit: mm (in)

		MEASUREMENT	STANDARD (NEW)	SERVICE LIMIT
Compression	250 min ⁻¹ (rpm) and wide-open throttle	Nominal	—	1,275 kPa (13.0 kg/cm ² 185 psi)
		Minimum	—	932 kPa (9.5 kg/cm ² 135 psi)
		Maximum variation	—	196 kPa (2 kg/cm ² , 28 psi)
Cylinder head	Warpage Height		—	0.05 (0.002)
			141.95—142.05 (5.589—5.593)	—
Camshaft	End play		0.05—0.15 (0.002—0.006)	0.05 (0.02)
		Oil clearance	0.050—0.089 (0.002—0.004)	0.15 (0.005)
	Runout		0—0.015 (0—0.0006)	0.03 (0.0012)
		Cam lobe height	IN Primary	33.088 (1.3027)
		Mid	36.267 (1.4278)	—
		Secondary	34.987 (1.3774)	—
		EX Primary	32.785 (1.2907)	—
		Mid	35.720 (1.4063)	—
	Secondary	34.691 (1.3658)	—	
Valve	Valve clearance	IN	0.15—0.19 (0.0059—0.0075)	—
		EX	0.17—0.21 (0.0067—0.0083)	—
	Valve stem O.D.	IN	5.475—5.485 (0.2156—0.2159)	5.445 (0.2144)
		EX	5.450—5.460 (0.2146—0.2150)	5.420 (0.2134)
	Stem-to-guide clearance	IN	0.035—0.045 (0.0014—0.0018)	0.075 (0.0030)
		EX	0.050—0.080 (0.0020—0.0031)	0.120 (0.0047)
Valve seat	Width	IN and EX	1.25—1.55 (0.049—0.061)	2.0 (0.08)
	Stem installed height	IN	37.465—37.935 (1.4750—1.4935)	38.185 (1.5033)
		EX	37.165—37.635 (1.4632—1.4817)	37.885 (1.4915)
Valve spring	Free length	IN Outer	40.70 (1.6024)*1 40.71 (1.6028)*2	} 39.61 (1.5594)
		Inner	36.70 (1.4449)*1 36.74 (1.4465)*2	
		EX	41.65 (1.6400)*1 41.64 (1.6394)*2	} 40.63 (1.5596)
Valve guide	I.D.	IN and EX	5.51—5.53 (0.2169—0.2177)	5.53 (0.2177)
	Installed height	IN and EX	12.55—13.05 (0.4941—0.5138)	13.30 (0.5236)
Rocker arm	Arm-to-shaft clearance	IN and EX	0.025—0.052 (0.0010—0.0020)	0.080 (0.0031)

*1: NIPPON HATSUJU made

*2: CHUO HATSUJU made

Spesical Tools

Ref. No.	Tool Number	Description	Q'ty	Remarks
①	07999—PD6000A	PGM—FI Test Harness	1	
②	07JAZ—SH20100	R.P.M. Connecting Adapter	1	
③	07406—0070000	Low Pressure Gauge	1	
④	07LAK—PR30100	Gauge Joint Adaptor	1	New tool
⑤	07LAJ—PR30100	Valve Inspection Set	1	New tool
⑥	07LAJ—PR30200	Air Stopper	1	New tool
⑦	07744—0010400	Pin Driver, 5.0 mm	2	
⑧	07757—0010001	Valve Spring Compressor	1	
⑨	07757—PJ10200	Valve Spring Compressor Attachment	1	
⑩	07742—0010100	Valve Guide Remover, 5.5 mm	1	
⑪	07942—8920000	Valve Guide Driver, 5.0 mm	1	
⑫	07HAH—PJ70100	Valve Guide Reamer, 5.5 mm	1	
⑬	07HAD—PJ70200	Stem Seal Driver	1	
⑭	07LAA—PR30100	Tappet Adjusting Wrench	1	New tool
⑮	07JGG—0010100	Belt Tension Gauge	1	

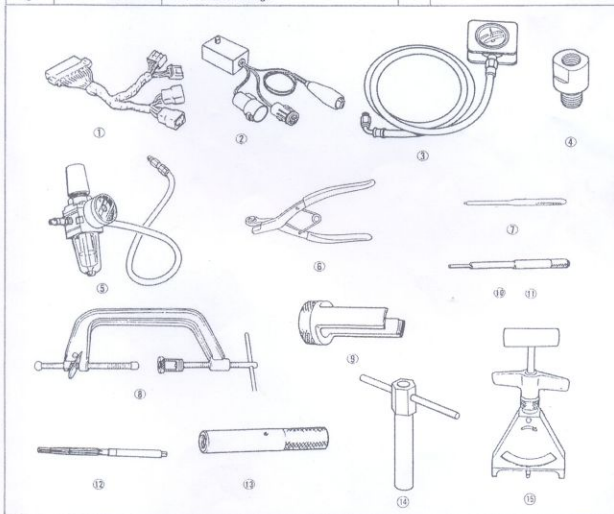

Cylinder Head/Valve Train

Illustrated Index

CAUTION:

- To avoid damaging the cylinder head, wait until the coolant temperature drops below 38°C (100°F) before removing it.
- In handling a metal gasket, care should be taken not to fold it or damage the contact surface of the gasket.

NOTE: Use new O-rings and gaskets when reassembling.

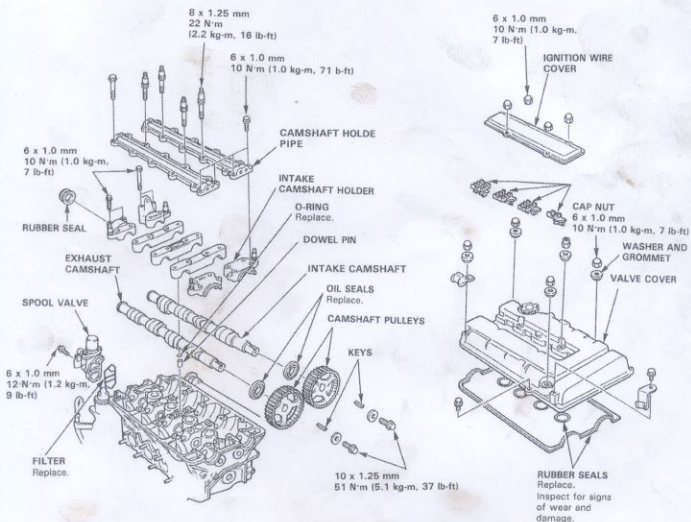

 Prior to reassembling, clean all the parts in solvent, dry them and apply lubricant to any contact parts.

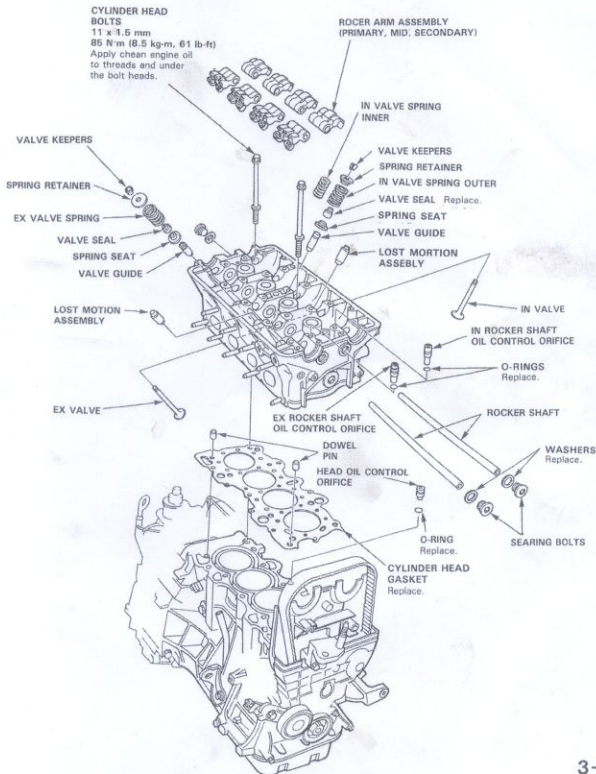

Engine Block

Special Tools	7-2	Piston Rings	
Illustrated Index	7-3	Replacement	7-14
Flywheel and Drive Plate		End Gap	7-14
Replacement	7-5	Ring-To-Groove Clearance	7-15
Main Bearings		Alignment	7-15
Clearance	7-6	Piston Pins	
Selection	7-6	Removal	7-16
Connecting Rod Bearings		Installation (B18A1 engine)	7-17
Clearance	7-7	Installation (B17A1 engine)	7-17
Selection	7-7	Inspection	7-18
Crankshaft		Connecting Rods	
Removal	7-8	End Play	7-19
End Play	7-9	Selection	7-19
Inspection	7-10	Oil Seal	
Installation	7-20	Installation	7-22
Cylinder Block		Installation	
Inspection	7-11	(engine removal not required) ...	7-22
Bore Honing	7-12		
Pistons			
Inspection	7-12		
Installation	7-13		



Special Tools

Ref. No	Tool Number	Description	Qty	Page Reference
①	07GAF—PH60300	Piston Pin Base Insert	1	7-16, 17
②	07HAF—PL20102	Piston Base Head	1	7-16, 17
③	07LAD—PR4010A	Seal Driver	1	7-22
④	07LAF—PR30100	Pilot Collar	1	7-16, 17
⑤	07LAB—PV00100 or 07924—PD20003 or 07924—PD20002	Ring Gear Holder	1	7-5
⑥	07948—SB00101	Driver Attachment	1	7-22
⑦	07749—0010000	Driver	1	7-22
⑧	07973—PE00310	Piston Pin Driver Shaft	1	7-16, 17
⑨	07973—PE00320	Piston Pin Driver Head	1	7-16, 17
⑩	07973—6570500	Piston Base	1	7-16, 17
⑪	07973—6570600	Piston Base Spring	1	7-16, 17

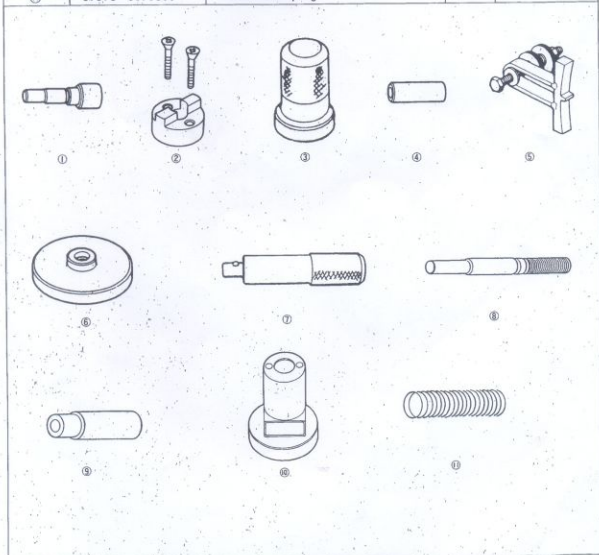

Illustrated Index



 Lubricate all internal parts with engine oil during reassembly.

NOTE:

- Apply liquid gasket to the mating surfaces of the right side cover and oil pump case before installing them.
- Use liquid gasket, Part No. 08718-0001.

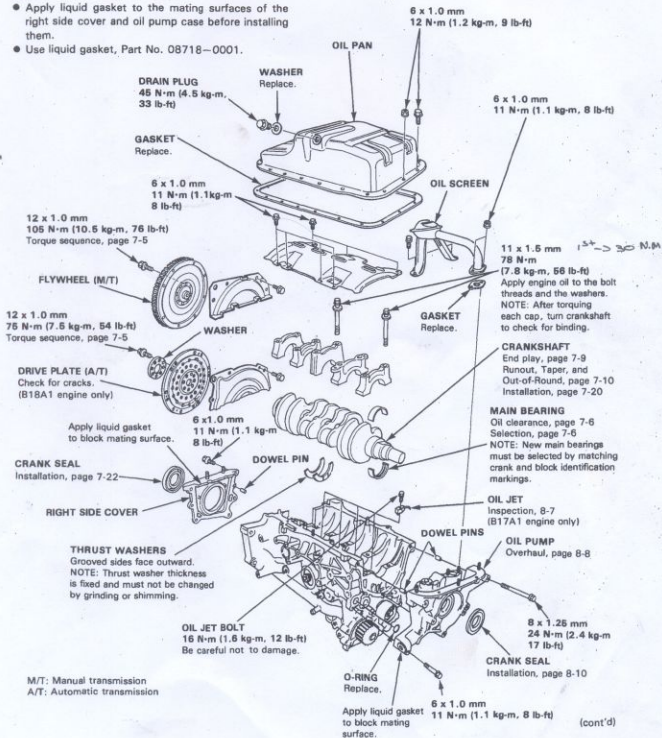

M/T: Manual transmission
A/T: Automatic transmission

Illustrated Index (cont'd)

NOTE: New rod bearings must be selected by matching connecting rod and crankshaft identification markings (page 7-7).

PISTON RINGS

Replacement, page 7-14
Measurement, pages 7-14 and 15
Alignment, page 7-15



PISTON INSTALLATION DIRECTION

EXHAUST

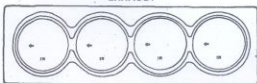

INTAKE

PISTON PIN

Removal, page 7-16
Installation, page 7-17
Inspection, page 7-18



PISTON

Removal, page 7-9
Measurement, page 7-12

Inspect top of each cylinder bore for carbon build-up or ridge before removing piston.
Remove ridge if necessary, page 7-8

CONNECTING ROD

End play, page 7-19
Selection, page 7-19
Small end measurement, page 7-18

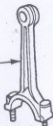

CONNECTING ROD BEARINGS

Clearance, page 7-7
Selection, page 7-7

CONNECTING ROD BEARING CAP

Installation, page 7-20
NOTE: Install caps so the bearing recess is on the same side as the recess in the rod.

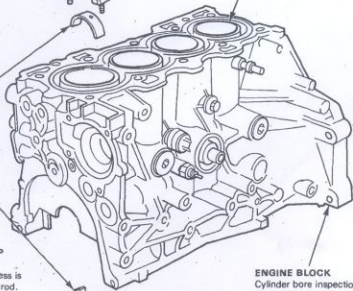

ENGINE BLOCK

Cylinder bore inspection, page 7-11
Warpage inspection, page 7-11
Cylinder bore honing, page 7-12

CONNECTING ROD NUT

8 x 0.75 mm
32 N•m (3.2 kg-m, 23 lb-ft)
After torquing each bearing cap, rotate crankshaft to check for binding.

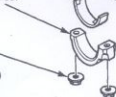

Flywheel and Drive Plate



Replacement

Manual Transmission:

Remove the eight flywheel bolts, then separate the flywheel from the crankshaft flange. After installation, tighten the bolts in the sequence shown.

RING GEAR HOLDER
07LAB—PV00100,
07924—PD20003 or
07924—PD20002



ENGINE
BLOCK

07LAB—PV00100,
07924—PD20003 or
07924—PD20002

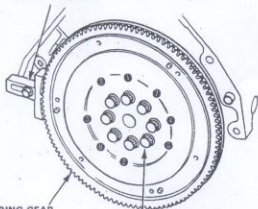

RING GEAR
Inspect ring gear
teeth for wear or
damage.

12 x 1.0 mm
105 N·m
(10.5 kg·m, 76 lb-ft)

Automatic Transmission:

Remove the eight drive plate bolts, then separate the drive plate from the crankshaft flange. After installation, tighten the bolts in the sequence shown.

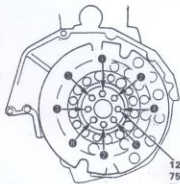

12 x 1.0 mm
75 N·m
(7.5 kg·m, 54 lb-ft)

Main Bearings

Clearance

- To check main bearing-to-journal oil clearance, remove the main caps and bearing halves.
- Clean each main journal and bearing half with a clean shop towel.
- Place one strip of plastigage across each main journal.

NOTE: If the engine is still in the car when you bolt the main cap down to check clearance, the weight of the crankshaft and flywheel will flatten the plastigage further than just the torque on the cap bolt, and give you an incorrect reading. For an accurate reading, support the crank with a jack under the counterweights and check only one bearing at a time.

- Reinstall the bearings and caps, then torque the bolts to 78 N·m (7.8 kg-m, 56 lb-ft) (page 7-20).
NOTE: Do not rotate the crankshaft during inspection.

- Remove the cap and bearings again, and measure the widest part of the plastigage.

Main Bearing-to-Journal Oil Clearance:

Standard (New):

No. 1, 2, 4, 5: 0.024–0.042 mm
(0.0009–0.0017 in)

Service Limit: 0.050 mm (0.0020 in)

No. 3: 0.030–0.048 mm
(0.0012–0.0019 in)

Service Limit: 0.060 mm (0.0024 in)

PLASTIGAGE STRIP

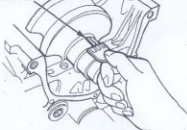

- If the plastigage measures too wide or too narrow, (remove the engine if it's still in the car), remove the crankshaft, and remove the upper half of the bearing. Install a new, complete bearing with the same color code (select the color as shown in the right column), and recheck the clearance.

CAUTION: Do not file, shim, or scrape the bearings or the caps to adjust clearance.

- If the plastigage shows the clearance is still incorrect, try the next larger or smaller bearing (the color listed above or below that one), and check again.

NOTE: If the proper clearance cannot be obtained by using the appropriate larger or smaller bearings, replace the crankshaft and start over.

Selection

CAUTION: If the codes are indecipherable because of an accumulation of dirt and dust, do not scrub them with a wire brush or driver. Clean them only with washing oil or detergent.

Crankshaft Bore Code Location (Letters)

Letters have been stamped on the end of the block as a code for the size of each of the 5 main journal bores. Use them, and the numbers or bars stamped on the crank (codes for main journal size), to choose the correct bearings.

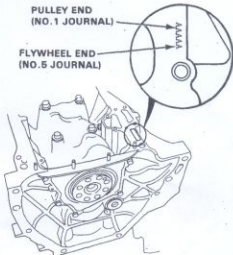

Main Journal Code Locations (Numbers or Bars)

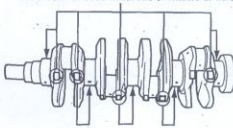

Bearing Identification

Color code is on the edge of the bearing.

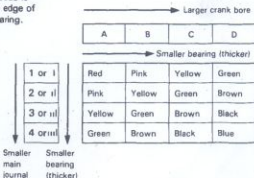

Connecting Rod Bearings



Clearance

1. Remove the connecting rod cap and bearing half.
2. Clean the crankshaft rod journal and bearing half with a clean shop towel.
3. Place the plastigage across the rod journal.
4. Reinstall the bearing half and cap, and torque the nuts to 32 N·m (3.2 kg·m, 23 lb·ft) (page 7-20).

NOTE: Do not rotate the crankshaft during inspection.

Connecting Rod Bearing-to-Journal Oil Clearance:

B18A1 engine:

Standard (New): 0.020–0.038 mm
(0.0008–0.0015 in)

Service Limit: 0.050 mm (0.0020 in)

B17A1 engine:

Standard (New): 0.032–0.050 mm
(0.0013–0.0020 in)

Service Limits: 0.060 mm (0.0024 in)

PLASTIGAGE STRIP

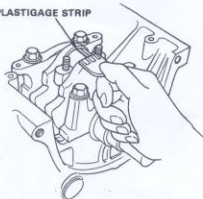

6. If the plastigage measures too wide or too narrow, remove the upper half of the bearing, install a new, complete bearing with the same color code (select the color as shown in the right column), and recheck the clearance.

CAUTION: Do not file, shim, or scrape the bearing or the caps to adjust clearance.

7. If the plastigage shows the clearance is still incorrect, try the next larger or smaller bearing (the color listed above or below that one), and check clearance again.

NOTE: If the proper clearance cannot be obtained by using the appropriate larger or smaller bearings, replace the crankshaft and start over.

Selection

CAUTION: If the codes are indecipherable because of an accumulation of dirt and dust, do not scrub them with a wire brush or driver. Clean them only with washing oil or detergent.

Connecting Rod Code Location (Numbers)

Number has been stamped on the side of each connecting rod as a code for the size of the big end. Use it, and the letters stamped on the crank (codes for rod journal size), to choose the correct bearings.

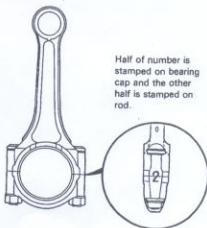

Half of number is stamped on bearing cap and the other half is stamped on rod.

Connecting Rod Journal Code Locations (Letters or Bars)

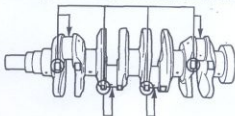

Bearing Identification

Color code is on the edge of the bearing.

→ Larger big end bore

1	2	3	4
---	---	---	---

→ Smaller bearing (thicker)

A or I	Red	Pink	Yellow	Green
B or II	Pink	Yellow	Green	Brown
C or III	Yellow	Green	Brown	Black
D or IIII	Green	Brown	Black	Blue

Smaller rod journal Smaller bearing (thicker)

Crankshaft

Removal

NOTE: End play for the connecting rods and crankshaft should be inspected before removing the crankshaft.

1. Remove the right side cover.

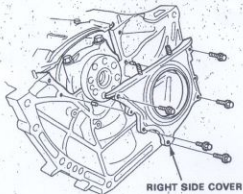

2. Remove the oil screen.

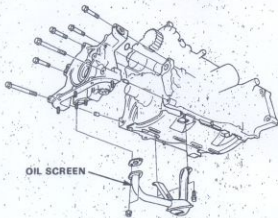

3. Remove the oil pump.
4. Remove the baffle plate.
5. Turn the crankshaft so No.2 and 3 crankpins are at the bottom.
6. Remove the rod caps/bearings and main caps/bearings. Keep all caps/bearings in order.
7. Lift the crankshaft out of the engine, being careful not to damage journals.

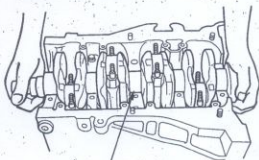

8. Remove the upper bearing halves from connecting rods and set them aside with their respective caps.
9. Reinstall main caps and bearings on the engine in proper order.
10. If you can feel a ridge of metal or hard carbon around the top of each cylinder, remove it with a ridge reamer. Follow the reamer manufacturer's instructions.

CAUTION: If the ridge is not removed, it may damage the pistons as they are pushed out.

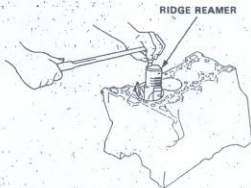



11. Use the wooden handle of a hammer to drive the pistons out.

CAUTION:

- Take care not to damage the contact surface of the metal gasket.
- When removing the piston/connecting rod, take care not to hit the oil jet (B17A1 engine only).
- If the oil jet nozzle is damaged or bent, replace the oil jet assembly (B17A1 engine only, page 8-7).

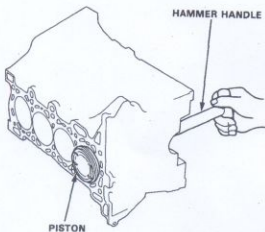

12. Reinstall the rod bearings and caps after removing each piston/connecting rod assembly.
13. Mark each piston/connecting rod assembly with its cylinder number to avoid mixup on reassembly.

NOTE: The existing number on the connecting rod does not indicate its position in the engine, it indicates the rod bore size.

End Play

NOTE: End play should be inspected before removing crankshaft.

Push the crank firmly away from the dial indicator, and zero the dial against the end of the crank. Then pull the crank firmly back toward the indicator; dial reading should not exceed service limit.

SCREWDRIIVER

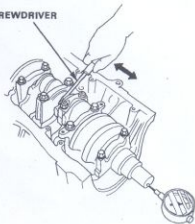

Crankshaft End Play:

Standard (New): 0.10–0.35 mm
(0.04–0.014 in)

Service Limit: 0.45 mm (0.018 in)

- If end play is excessive, inspect the thrust washers and thrust surface on the crankshaft. Replace parts as necessary.

NOTE:

- Thrust washer thickness is fixed and must not be changed either by grinding or shimming.
- Thrust washers are installed with grooved sides facing outward.

Crankshaft

Inspection

NOTE:

- Clean the crankshaft oil passages with pipe cleaners or a suitable brush.
- Check the keyway and threads.

Alignment

- Measure runout on all main journals to make sure the crank is not bent.
- The difference between measurements on each journal must not be more than the service limit.

Crankshaft Total Indicated Runout:

B18A1 engine:

Standard (New): 0.03 mm (0.001 in) max.

Service Limit: 0.05 mm (0.002 in)

B17A1 engine:

Standard (New): 0.020 mm (0.0008 in) max.

Service Limits: 0.030 mm (0.0012 in)

DIAL INDICATOR

Rotate two complete revolutions.

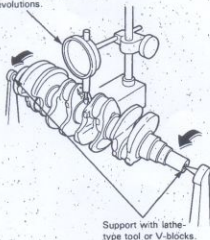

Support with lathe-type tool or V-blocks.

Out-of-Round and Taper

- Measure out-of-round at the middle of each rod and main journal in two places.
- The difference between measurements on each journal must not be more than the service limit.

Journal Out-of-Round:

B18A1 engine:

Standard (New): 0.005 mm (0.0002 in) max.

Service Limit: 0.010 mm (0.0004 in)

B17A1 engine:

Standard (New): 0.004 mm (0.00016 in) max.

Service Limit: 0.006 mm (0.00024 in)

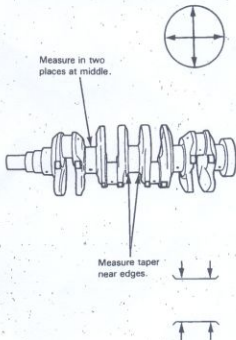

- Measure taper at the edges of each rod and main journal.
- The difference between measurements on each journal must not be more than the service limit.

Journal Taper:

B18A1 engine:

Standard (New): 0.005 mm (0.0002 in) max.

Service Limit: 0.010 mm (0.0004 in)

B17A1 engine:

Standard (New): 0.005 mm (0.0002 in) max.

Service Limit: —

Cylinder Block



Inspection

1. Measure wear and taper in direction X and Y at three levels in each cylinder as shown.

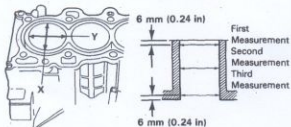

CYLINDER BORE GAUGE

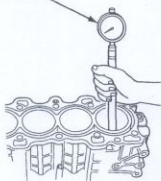

Cylinder Bore Size:

Standard (New): X: 81.000–81.020 mm
(3.1890–3.1898 in)

Y: 81.000–81.015 mm
(3.1890–3.1896 in)

Service Limit: 81.07 (3.192 in)

Oversize:

0.25: 81.250–81.270 mm (3.1988–3.1996 in)

Bore Taper:

Service Limit: (Difference between first and third measurement) 0.05 mm (0.002 in)

- If measurements in any cylinder are beyond Oversize Bore Service Limit, replace the block.
- If the block is to be rebored, refer to Piston Clearance Inspection (page 7-12) after reboring.

NOTE: Scored or scratched cylinder bores must be honed.

Reboring Limit: 0.25 mm (0.01 in)

2. Check the top of the block for warpage. Measure along the edges and across the center as shown.

SURFACES TO BE MEASURED

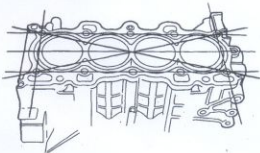

Engine Block Warpage:

B18A1 engine:

Standard (New): below 0.07 mm (0.003 in)

Service Limit: 0.10 mm (0.004 in)

B17A1 engine:

Standard (New): below 0.05 mm (0.002 in)

Service Limit: 0.08 mm (0.003 in)

PRECISION STRAIGHT EDGE

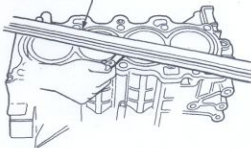

Cylinder Block

Bore Honing

1. Measure cylinder bores as shown on page 7-11. If the block is to be reused, hone the cylinders and remeasure the bores.
2. Hone cylinder bores with honing oil and a fine (400 grit) stone in a 60 degree cross-hatch pattern.
NOTE:
 - Use only a rigid hone with 400 grit or finer stone such as Sunnen, Ammco, or equivalent.
 - Do not use stones that are worn or broken.



3. When honing is complete, thoroughly clean the engine block of all metal particles. Wash the cylinder bores with hot soapy water, then dry and oil immediately to prevent rusting.

NOTE: Never use solvent, it will only redistribute the grit on the cylinder walls.

4. If scoring or scratches are still present in cylinder bores after honing to the service limit, rebore the engine block.

NOTE: Some light vertical scoring and scratching is acceptable if it is not deep enough to catch your fingernail and does not run the full length of the bore.

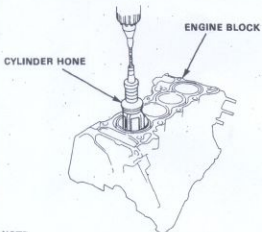

NOTE:

- After honing, clean the cylinder thoroughly with soapy water.
- Only scored or scratched cylinder bores must be honed.

Pistons

Inspection

1. Check the piston for distortion or cracks.

NOTE: If the cylinder is bored, an oversized piston must be used.

2. Measure the piston diameter at a point 15 mm (0.6 in) from the bottom of the skirt.

Piston Diameter:

Standard (New): 80.980–80.990 mm

(3.1882–3.1886 in)

Service Limit: 80.970 mm (3.1878 in)





3. Calculate the difference between cylinder bore diameter on (page 7-11) and piston diameter.

Piston-to-Cylinder Clearance:

Standard (New): 0.010–0.035 mm
(0.0004–0.0014 in)

Service Limit: 0.05 mm(0.002 in)

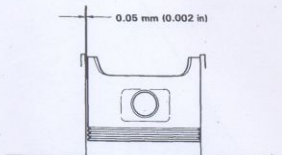

If the clearance is near or exceeds the service limit, inspect the piston and cylinder block for excessive wear.

Oversize Piston Diameter:

0.25: 81.23–81.24 mm (3.1980–3.1984 in)

Installation



Before installing the piston, apply a coat of engine oil to the ring grooves and cylinder bores.

1. If the crankshaft is already installed:
 - Remove the connecting rod caps and slip short sections of rubber hose over the threaded ends of the connecting rod bolts.
 - Install the ring compressor, check that the bearing is securely in place, then position the piston in the cylinder and tap it in using the wooden handle of a hammer.Stop after the ring compressor pops free and check the connecting rod-to-crank journal alignment before tapping piston into place.
 - Install the rod caps with bearings, then torque the nuts to 32 N·m(3.2 kg·m, 23 lb·ft).
2. If the crankshaft is not installed:
 - Remove the rod caps and bearings, install the ring compressor, then position the piston in the cylinder and tap it in using the wooden handle of a hammer.
 - Position all pistons at top dead center.



The arrow must face the timing belt side of the engine. The connecting rod oil hole must face the intake manifold (B18A1 engine).

CONNECTING ROD OIL HOLE (B18A1 engine)

NOTE: Maintain downward force on the ring compressor to prevent rings from expanding before entering the cylinder bore.

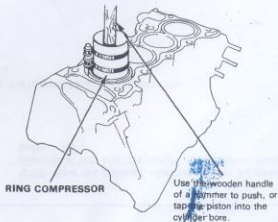

Piston Rings

Replacement

1. Using a ring expander, remove old piston rings.
2. Clean all ring grooves thoroughly.

NOTE:

- Use a squared-off broken ring or ring groove cleaner with blade to fit piston grooves.
- Top ring groove is 1.0 mm wide, second groove is 1.2 mm wide, and oil ring groove is 2.8 mm wide.
- File down blade if necessary.

CAUTION: Do not use a wire brush to clean the ring lands, or cut ring lands deeper with cleaning tool.

NOTE: If the piston is to be separated from the connecting rod, do not install new rings yet.

3. Install new rings in the proper sequence and position (page 7-15).

NOTE: Do not use old piston rings.

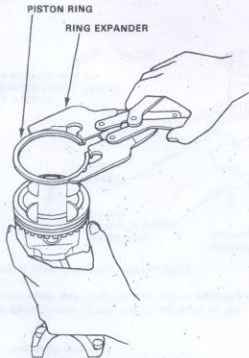

End Gap

1. Using a piston, push a new ring into the cylinder bore 15–20 mm (0.6–0.8 in) from the bottom.
2. Measure the piston ring end-gap with a feeler gauge:

- If the gap is too small, check to see if you have the proper rings for your engine.
- If the gap is too large, recheck the cylinder bore diameter against the wear limits on page 7-11. If the bore is over the service limit, the engine block must be rebored.

Piston Ring End-Gap:

Top Ring

Standard (New): 0.20–0.30 mm
(0.008–0.012 in)^{*1}
0.20–0.35 mm
(0.008–0.014 in)^{*2}

Service Limit: 0.60 mm (0.024 in)

Second Ring

Standard (New): 0.40–0.55 mm
(0.016–0.022 in)
Service Limit: 0.70 mm (0.028 in)

Oil Ring

Standard (New): 0.20–0.45 mm
(0.008–0.018 in)^{*1}
0.20–0.50 mm
(0.008–0.020 in)^{*2}

Service Limit: 0.70 mm (0.028 in)

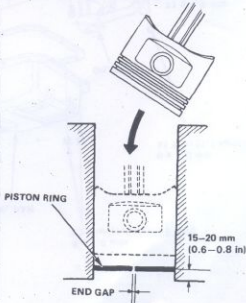

*1: TEIKOKU PISTON RING manufactured piston ring

*2: RIKEN manufactured piston ring



Ring-to-Groove Clearance

After installing a new set of rings, measure the ring-to-groove clearances:

Top Ring Clearance:

Standard (New): 0.045–0.070 mm
(0.0018–0.0028 in)^{*1}

Service Limit: 0.13 mm (0.005 in)

Second Ring Clearance:

Standard (New): 0.045–0.070 mm
(0.0018–0.0028 in)^{*1}

0.040–0.065 mm
(0.0015–0.0026 in)^{*2}

Service Limit: 0.13 mm (0.005 in)

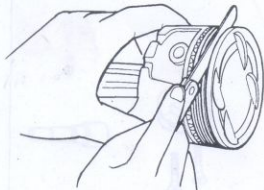

*1: TEIKOKU PISTON RING manufactured piston ring

*2: RIKEN manufactured piston ring

Alignment

1. Install the rings as shown.

Identify top and second rings by the chamfer on the edge. Make sure they are in their proper grooves on the piston.

NOTE: The manufacturing marks must be facing upward.

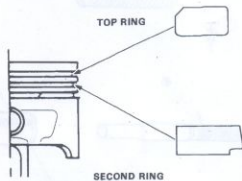

2. Rotate the rings in their grooves to make sure they do not bind.

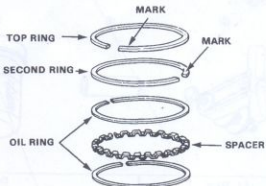

3. Position the ring end gaps as shown:

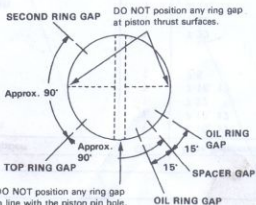

Piston Pins

Removal

1. Assemble the Piston Pin Tools, as shown.

PISTON BASE HEAD
07HAF-PL20102

PISTON PIN BASE INSERT
07GAF-PH60300

PISTON BASE SPRING
07973-6570600

PISTON BASE
07973-6570500

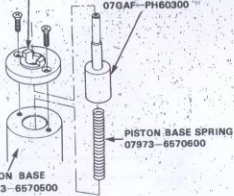

2. Adjust the length A of the piston pin driver.

A: B18A1 engine: 49.70 mm (1.957 in)
B17A1 engine: 51.70 mm (2.035 in)

PISTON PIN DRIVER HEAD
07973-PE00320

PISTON PIN DRIVER SHAFT
07973-PE00310

PILOT COLLAR
07LAF-PR30100

Embossed mark facing up.

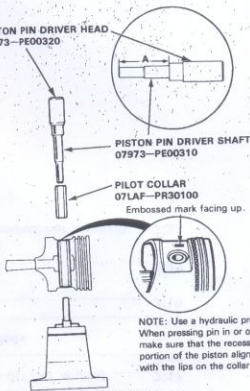

NOTE: Use a hydraulic press.
When pressing pin in or out,
make sure that the recessed
portion of the piston aligns
with the lips on the collar.

3. Place the piston on the piston base and press the pin out with a hydraulic press.



Installation (B18A1 engine)

1. Use a hydraulic press for installation.

- When pressing the pin in or out, be sure to position the recessed flat on the piston against the lugs on the base attachment.

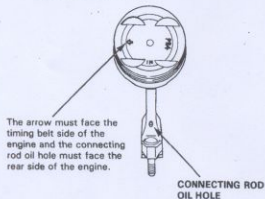

2. Adjust the length B of the piston pin driver.
B: 49.70 mm (1.957 in)

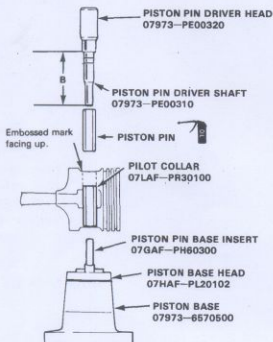

NOTE: Install the assembled piston and rod with the oil hole facing the intake manifold.

Installation (B17A1 engine)

1. Use a hydraulic press for installation.

- When pressing pin in or out, be sure you position the recessed flat on the piston against the lugs on the base attachment.

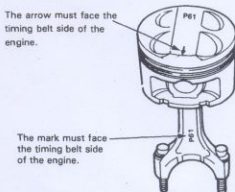

2. Adjust the length B of piston pin driver.
B: 51.70 mm (2.035 in)

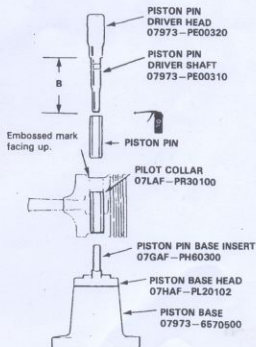

Piston Pins

Inspection

1. Measure the diameter of the piston pin.

Piston Pin Diameter:

Standard (New): 20.994–21.000 mm
(0.8265–0.8268 in)

Oversize: 20.997–21.003 mm
(0.8267–0.8269 in)

NOTE: All replacement piston pins are oversize.

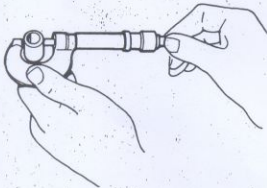

2. Zero the dial indicator to the piston pin diameter.

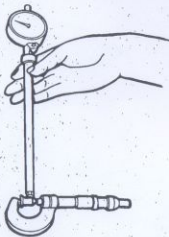

3. Measure the piston pin-to-piston clearance.

NOTE: Check the piston for distortion or cracks.

If the piston pin clearance is greater than 0.022 mm (0.0009 in), remeasure using an oversize piston pin.

Piston Pin-to-Piston Clearance:

Standard (New): 0.010–0.022 mm
(0.0004–0.0009 in)



4. Check the difference between piston pin diameter and connecting rod small end diameter.

Piston Pin-to-Connecting Rod Interference:

Standard (New): 0.013–0.032 mm
(0.0005–0.0013 in)

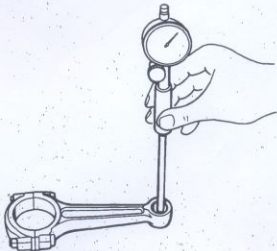

Connecting Rods

End Play

NOTE: End play should be inspected before removing the crankshaft.

Connecting Rod End Play:

Standard (New): 0.15–0.30 mm
(0.006–0.012 in)

Service Limit: 0.40 mm (0.016 in)

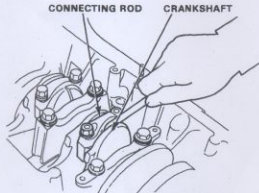

- If out-of-tolerance, install a new connecting rod.
- If still out-of-tolerance, replace the crankshaft (page 7-8 and 7-20)

Selection

Each rod falls into one of four tolerance ranges (from 0 to + 0.024 mm, in 0.006 mm increments) depending on the size of its big end bore. It's then stamped with a number (1, 2, 3, or 4) indicating the range. You may find any combination of 1, 2, 3, or 4 in any engine.

Normal Bore Size: 48.0 mm (1.89 in)

NOTE:

- Reference numbers are for big end bore size and do NOT indicate the position of the rod in the engine.
- Inspect connecting rod for cracks and heat damage.

CONNECTING ROD BORE REFERENCE NUMBER

Half of number is stamped on bearing cap, the other half on connecting rod.

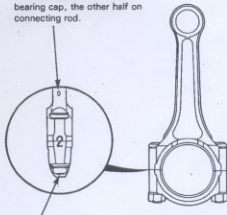

Inspect bolts and nuts for stress cracks.

Crankshaft

Installation

Before installing the crankshaft, apply a coat of engine oil to the main bearings and rod bearings.

1. Insert bearing halves in the engine block and connecting rods.
2. Hold the crankshaft so rod journals for cylinders No. 2 and No. 3 are straight up.
3. Lower the crankshaft into the block, seating the rod journals into connecting rods No. 2 and No. 3. Install the rod caps and nuts finger tight.

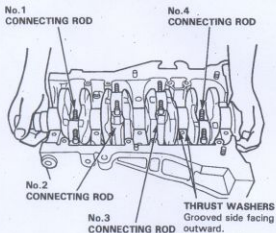

4. Rotate the crankshaft clockwise, seat journals into connecting rods No. 1 and No. 4, and install the rod caps and nuts finger tight.

NOTE: Install caps so the bearing recess is on the same side as the recess in the rod.

5. Check rod bearing clearance with plastigage (page 7-7) then tighten the capnuts in 2 steps.

1st step: 20 N·m (2.0 kg-m, 14 lb-ft)

2nd step: 32 N·m (3.2 kg-m, 23 lb-ft)

NOTE: Reference numbers on connecting rod are for big-end bore tolerance and do NOT indicate the position of piston in the engine.

6. Install the thrust washers and main bearing caps. Check clearance with plastigage (page 7-6); then tighten the bearing cap bolts in 2 steps.

In the first step tighten all bolts in sequence to about 30 N·m (3.0 kg-m, 22 lb-ft); in the final step tighten in same sequence to 78 N·m (7.8 kg-m, 56 lb-ft).

NOTE: Coat the bolt threads with oil.

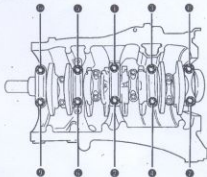

CAUTION: Whenever any crankshaft or connecting rod bearing is replaced, it is necessary after reassembly to run the engine at idling speed until it reaches normal operating temperature, then continue to run it for approximately 15 minutes.

7. Install the baffle plate.
8. Apply non-hardening liquid gasket to the block mating surface of the right side cover and oil pump, and install them on the engine block.

RIGHT SIDE COVER:

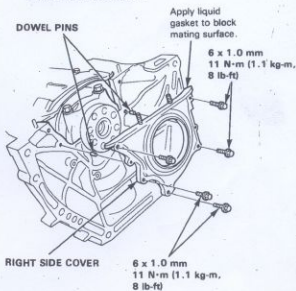



OIL PUMP:

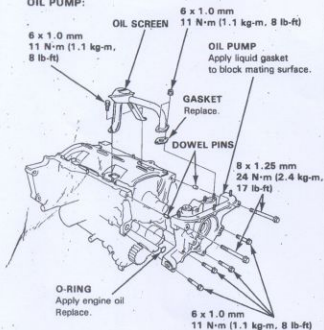

NOTE:

- Use liquid gasket, Part No. 08718-0001.
- Check that the mating surfaces are clean and dry before applying liquid gasket.
- Apply liquid gasket as an even bead, centered between the edges of the mating surface.
- To prevent leakage of oil, apply liquid gasket to the inner threads of the bolt holes.
- Do not install the parts if 20 minutes or more have elapsed since applying the liquid gasket. Instead, reapply liquid gasket after removing the old residue.
- After assembly, wait at least 30 minutes before filling the engine with oil.

RIGHT SIDE COVER:

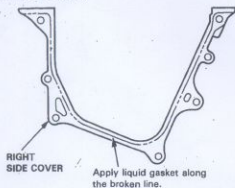

OIL PUMP:

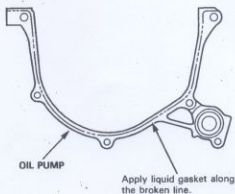

9. Install the oil screen.
10. Install the oil pan.



11. Tighten the bolts as shown below.
Torque: 12 N·m (1.2 kg-m, 9 lb-ft)

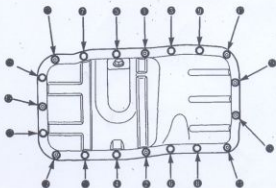

NOTE: Tighten the bolts and nuts in two steps and torque the bolts in a criss-cross pattern.

Oil Seal

Installation

-  The seal surface on the block should be dry. Apply a light coat of oil to the crankshaft and to the lip of the seal.

1. Drive in flywheel end seal against right side cover.
NOTE: Drive the end seal in squarely.

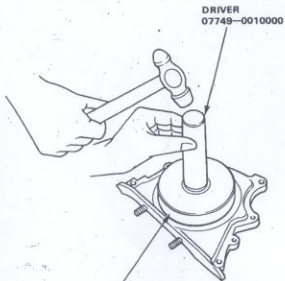

DRIVER ATTACHMENT
07948-SB00101

Install seal with the part number side facing out.

2. Confirm that clearance is equal all the way around with a feeler gauge.

Clearance: 0.5-0.8 mm (0.02-0.03 in)

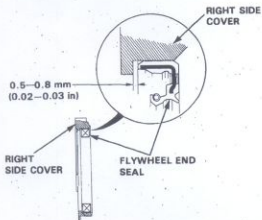

NOTE: Refer to right column and 8-10 for installation of the oil pump side oil seal.

Installation (engine removal not required)

-  The seal surface on the block should be dry. Apply a light coat of grease to the crankshaft and to the lip of seal.

1. Using the special tool, drive in the timing pulley-end seal until the driver bottoms against the oil pump. When the seal is in place, clean any excess grease off the crankshaft and check that the oil seal lip is not distorted.

SEAL DRIVER
07LAD-PR4010A
Install seal with the part number side facing out.

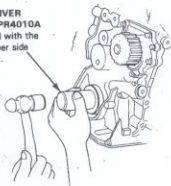

2. Using the special tool, drive in the flywheel-end seal until the driver bottoms against block.

NOTE: Align the hole in the driver attachment with the pin on the crankshaft.

